



WATER
PUMPS
YOU CAN
TRUST

4"

50
Hz



NPS4
SERIES
TECH
DETAILS

ELECTRIC STAINLESS BOREHOLE PUMPS COVERCO SERIE NPS4

Multistage electric borehole stainless steel pumps available in a complete range so as to perfectly suit whatever duty point requested by the user. Coverco pumps have a compact stainless construction combining strength and reliability and quality of production materials. High performances and efficiency with limited dimensions. Components and materials to grant the maximum reliability in hard conditions: hydraulic components in Noryl/Polycarbonate to increase the wear resistance.

- Diffusers in Noryl
- SS 304 stainless steel shaft
- SS 316 washer
- Bushing made of Polycarbonate and SS 316
- Coupling in stainless steel SS 304
- Body stage in one piece entirely in stainless steel SS 304/430: it gives rigidity to the whole structure ensuring high mechanical resistance and easiness of disassembly
- Check valve in stainless steel and rubber to reduce the pressure drops, to ensure a tight seal under all conditions and to avoid pump block
- Configuration designed for easy disassembly, maintenance and assembly
- Submersible motor original COVERCO brand
- Coupling in SS 304 with dimensions according to NEMA regulations

The used materials are suitable to the contact with drinkable water

APPLICATIONS

- Municipal water works, fountains and waste water
- Water distribution and pressure boosting
- Irrigation and sprinkler systems, water treatment plants, filtration and reverse osmosis
- Industrial cooling and processing
- Mining industry, drainage and dewatering
- Fire-fighting equipment
- Water supply to and from tanks, reservoir and wells
- Lifting and distribution of a wide range of liquids
- Autoclave and cistern charge and discharge
- Turf and landscape
- Greenhouses and nurseries
- Residential and farm wells and drainage
- Food industry
- General industry

FEATURES

- Compact, reliable and suited to operate in horizontal position
- Built-in check valve to protect the pump against water hammer risk
- Floating impellers to grant a better performance and longer life for the pump against abrasion
- The hydraulic design is such to enhance the overall efficiency thus reducing energy consumption and making the pumping systems more cost effective

SPECIFICATIONS

- Rotation CCW 2900 R.p.m. at 50Hz
- Capacities up to 24 m³/h at 50Hz
- Pumped liquid: chemically and mechanically non aggressive
- Water temperature range: from 0°C to 40°C
- Maximum allowable amount of sand 25 gr/m³, solid dimension max 2mm
- Maximum pump diameter (including cable guard): 95mm
- Outlet diameter: 1 1/4" SN 401, 402, 403, 404 and 2" SN 406, 408, 409, 412, 415.
- Rotation: counter clockwise when looking into the discharge
- Motor adapter joint in compliance with NEMA standard
- Pump can work continuously in vertical or horizontal position

CONFORMITIES - PUMP

- According to Nema Standard EN ISO 9906
- Tolerance of curves according to EN 9906 Appendix A
- Hydraulic characteristics of catalog don't include the loss of check-valve
- The hydraulic working characteristics have been calculated with water at 15°C at the atmospheric pressure of 1 bar
- Performance curves are based on the kinematic viscosity $\nu = 1\text{mm}^2/\text{s}$ and density $\rho = 1000\text{ kg / m}^3$

CONFORMITIES - MOTOR

- References and characteristics included in Coverco yellow technical products catalogue and motors manual. Motor units in compliance with:
 - IEC 60034-1 standards
 - NEMA MG 1-2006: 18.157
 - standards **CE** (2006/95/EC Low Voltage Directive – 2004/108/EC Electromagnetic compatibility – 2011/65/EU RoHS II)
- Different voltages available

ACCESSORIES ON REQUEST

COVERCO control boxes (references and characteristics are included in Coverco yellow technical products catalogue and motors manual).

Coverco has the right to modify products characteristics and the details included in this catalogue without any prior notice.

SN 404

50Hz - TECHNICAL INFORMATIONS

Pump Type	Motor		Dimensions (mm)								Weight (kg)				
			1~	3~	1~	3~				1~	3~		1~	3~	
	HP	KW	L	L	E	E	B	∅=C	∅=D	∅=MAX	Motor		Pump	Total	Total
SN 404 / 04	0,5	0,37	364	350	639	625	275	93	1 1/4"	95	8,1	7,4	2,6	10,7	10
SN 404 / 07	0,75	0,55	389	364	734	709	345	93	1 1/4"	95	9,2	8	3,2	12,4	11,2
SN 404 / 10	1	0,75	411	384	821	794	410	93	1 1/4"	95	10,3	8,8	3,8	14,1	12,6
SN 404 / 14	1,5	1,1	434	411	929	906	495	93	1 1/4"	95	11,4	10,6	4,6	16	15,2
SN 404 / 18	2	1,5	467	428	1052	1013	585	93	1 1/4"	95	12,8	10,8	5,4	18,2	16,2
SN 404 / 27	3	2,2	565	467	1345	1247	780	93	1 1/4"	95	17,4	12,5	6,5	23,9	19
SN 404 / 32	4	3	-	522	-	1472	950	93	1 1/4"	95	-	15	8,4	-	23,4
SN 404 / 40	5	3,7	-	*	-	*	1125	93	1 1/4"	95	-	*	9,5	-	*
SN 404 / 44	5,5	4	-	587	-	1802	1215	93	1 1/4"	95	-	18,3	10,7	-	29

Pump Type	Motor		m ³ /h	0,0	1,8	2,1	2,4	2,7	3	3,3	3,6	4,2	4,8	5,4	6
				l/min	0	30	35	40	45	50	55	60	70	80	90
SN 404 / 04	0,5	0,37	Head in meters	26	23	23	22	22	21	20	19	18	15	12	8
SN 404 / 07	0,75	0,55		44	40	39	38	36	35	33	32	28	23	17	11
SN 404 / 10	1	0,75		65	59	58	56	54	52	50	47	42	35	27	18
SN 404 / 14	1,5	1,1		92	84	82	80	77	75	71	69	61	51	39	25
SN 404 / 18	2	1,5		119	109	107	104	100	97	93	90	79	66	51	33
SN 404 / 27	3	2,2		179	164	160	154	151	145	140	133	115	99	78	54
SN 404 / 32	4	3		211	197	192	186	181	173	167	159	141	118	93	66
SN 404 / 40	5	3,7		268	246	239	232	225	215	206	195	168	139	103	71
SN 404 / 44	5,5	4		292	272	265	256	247	238	226	214	184	150	120	85

* = motor unavailable

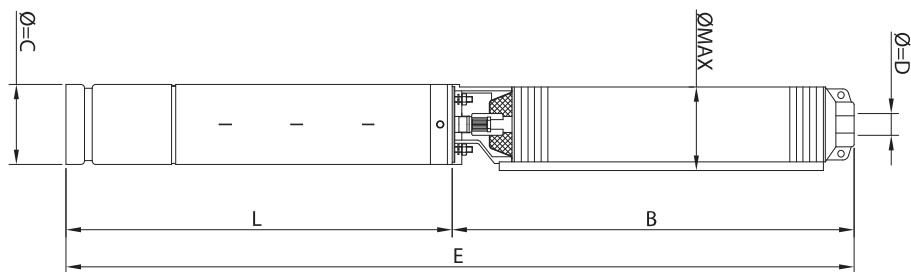

SN 404

50Hz - MANOMETRIC HEAD - PUMP EFFICIENCY

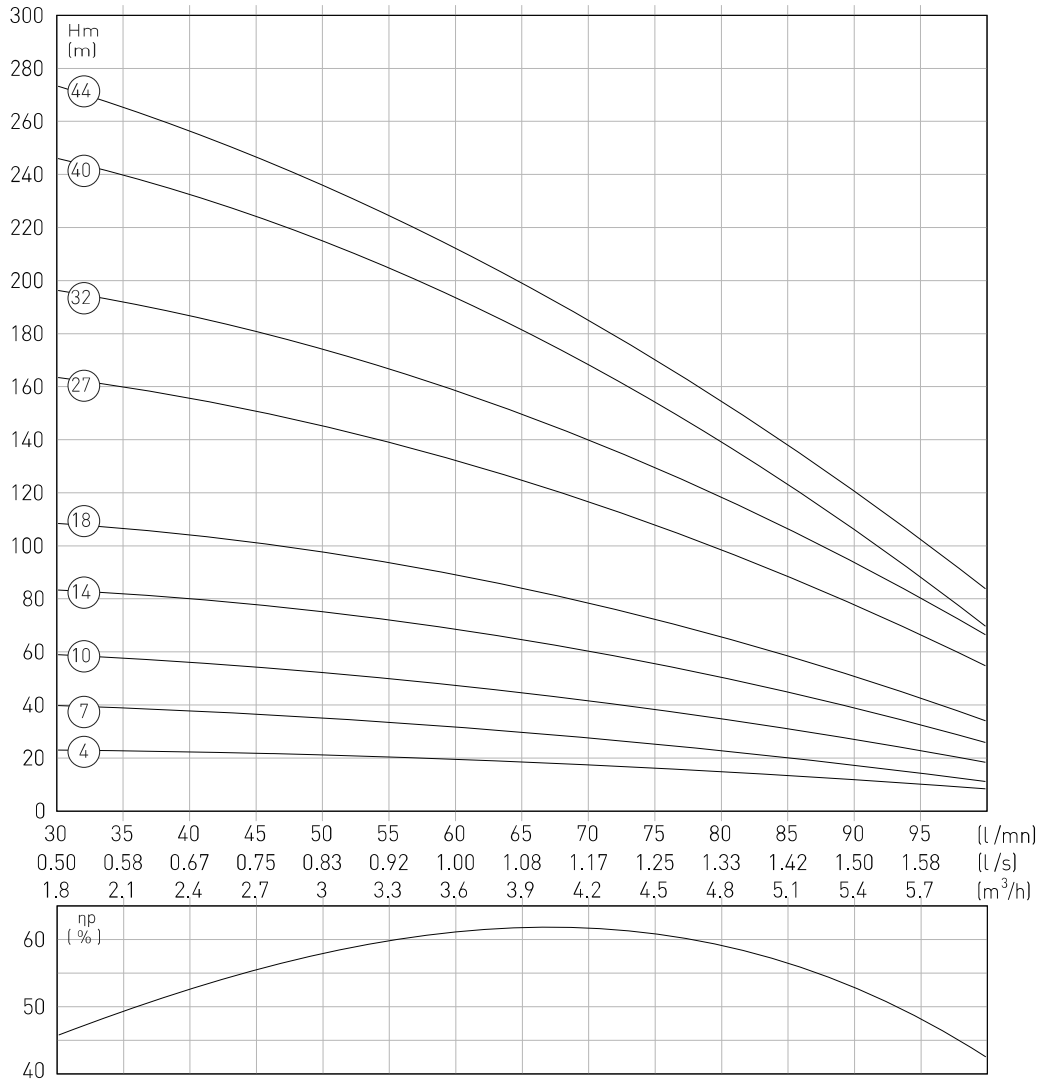

SN 406

50Hz - TECHNICAL INFORMATIONS

Pump Type	Motor		Dimensions (mm)								Weight (kg)				
			1~	3~	1~	3~				1~	3~		1~	3~	
	HP	KW	L	L	E	E	B	∅=C	∅=D	∅=MAX	Motor		Pump	Total	Total
SN 406 / 06	1	0,75	411	384	781	754	370	93	2"	95	10,3	8,8	2,9	13,2	11,7
SN 406 / 09	1,5	1,1	434	411	894	871	460	93	2"	95	11,4	10,6	3,6	15	14,2
SN 406 / 13	2	1,5	467	428	1077	1038	610	93	2"	95	12,8	10,8	4,8	17,6	15,6
SN 406 / 19	3	2,2	565	467	1385	1287	820	93	2"	95	17,4	12,5	6,6	24	19,1
SN 406 / 26	4	3	-	522	-	1552	1030	93	2"	95	-	15	7,9	-	22,9
SN 406 / 31	5	3,7	-	*	-	*	1220	93	2"	95	-	*	9,3	-	*
SN 406 / 34	5,5	4	-	587	-	1892	1305	93	2"	95	-	18,3	9,9	-	28,2
SN 406 / 45	7,5	5,5	-	687	-	2322	1635	93	2"	95	-	24,3	12,8	-	37,1

Pump Type	Motor		m ³ /h	Head in meters															
				0,0	2,7	3	3,3	3,6	4,2	4,8	5,4	6	7	7,2	8	8,4	9		
	HP	KW	l/min	0	45	50	55	60	70	80	90	100	116,6	120	133,3	140	150		
SN 406 / 06	1	0,75	Head in meters	35	33	33	32	32	31	30	29	27	23	23	19	16	13		
SN 406 / 09	1,5	1,1		52	48	48	47	47	45	43	41	38	33	32	26	21	18		
SN 406 / 13	2	1,5		78	74	73	73	72	71	68	65	62	55	53	45	37	31		
SN 406 / 19	3	2,2		109	103	102	102	100	98	94	89	83	73	70	60	51	41		
SN 406 / 26	4	3		151	142	141	139	138	133	125	118	108	93	89	74	64	48		
SN 406 / 31	5	3,7		186	173	172	170	167	160	152	141	130	112	109	90	78	56		
SN 406 / 34	5,5	4		201	188	187	185	183	176	165	154	139	120	116	95	84	64		
SN 406 / 45	7,5	5,5		268	253	252	249	248	237	225	212	192	161	154	129	117	99		

* = motor unavailable

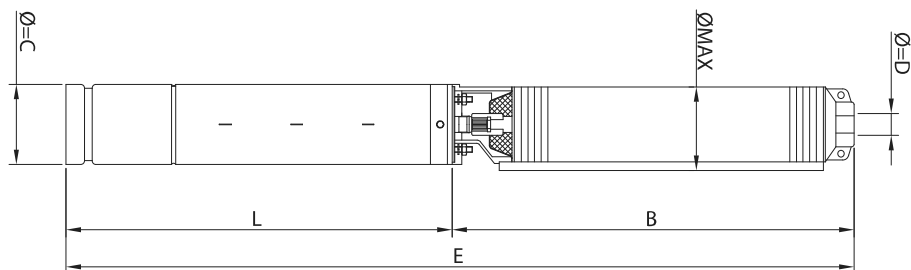

SN 406

50Hz - MANOMETRIC HEAD - PUMP EFFICIENCY

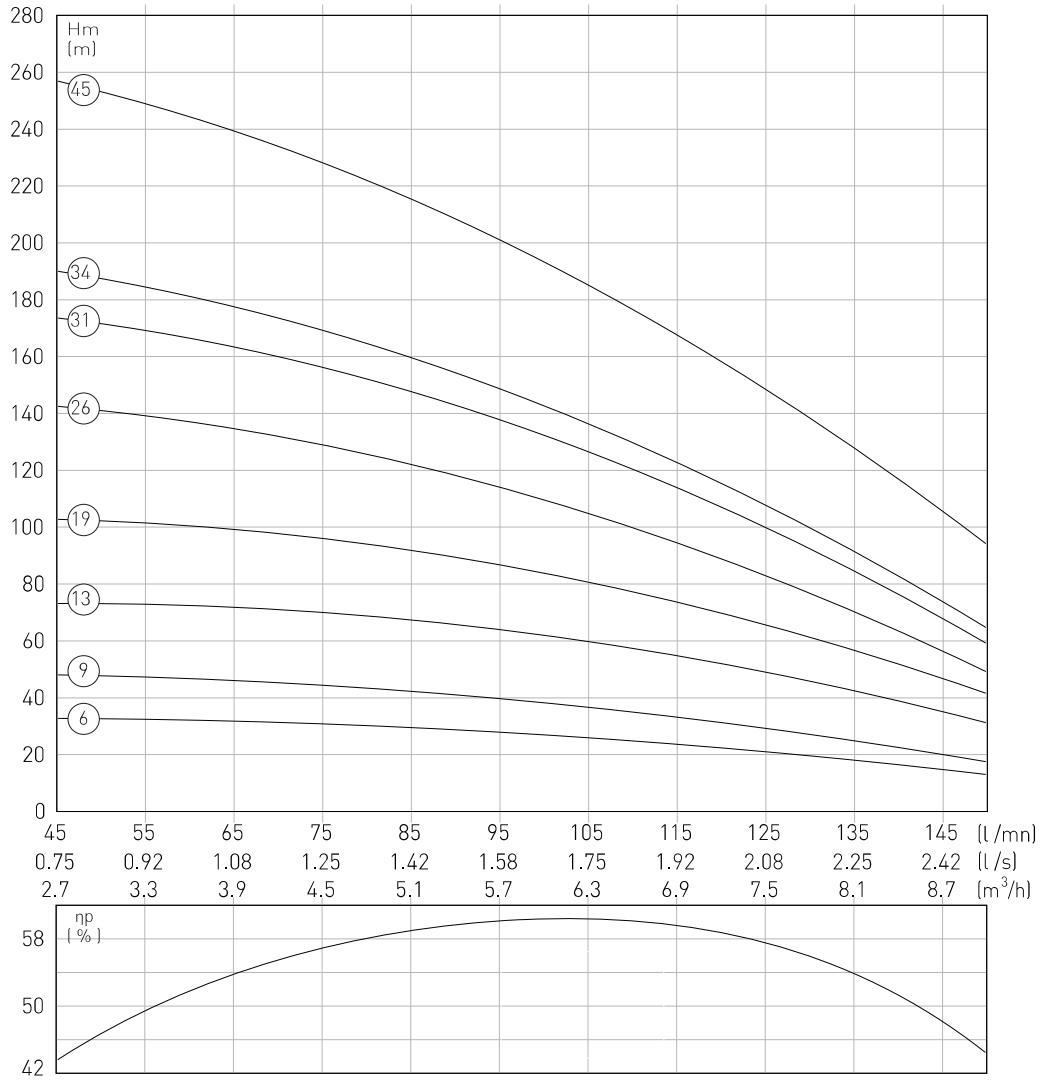

SN 408

50Hz - TECHNICAL INFORMATIONS

Pump Type	Motor		Dimensions (mm)								Weight (kg)				
			1~	3~	1~	3~				1~	3~		1~	3~	
	HP	KW	L	L	E	E	B	∅=C	∅=D	∅=MAX	Motor		Pump	Total	Total
SN 408 / 04	1	0,75	411	384	721	694	310	93	2"	95	10,3	8,8	2,6	12,9	11,4
SN 408 / 06	1,5	1,1	434	411	804	781	370	93	2"	95	11,4	10,6	2,9	14,3	13,5
SN 408 / 09	2	1,5	467	428	927	888	460	93	2"	95	12,8	10,8	3,6	16,4	14,4
SN 408 / 14	3	2,2	565	467	1205	1107	640	93	2"	95	17,4	12,5	4,9	22,3	17,4
SN 408 / 18	4	3	-	560	-	1325	765	93	2"	95	-	15	6	-	21
SN 408 / 21	5	3,7	-	*	-	*	885	93	2"	95	-	*	6,9	-	*
SN 408 / 23	5,5	4	-	587	-	1532	945	93	2"	95	-	18,3	7	-	25,3
SN 408 / 32	7,5	5,5	-	687	-	1932	1245	93	2"	95	-	24,3	9,2	-	33,5
SN 408 / 42	10	8	-	768	-	2340	1572	93	2"	95	-	28,3	11,6	-	39,9

Pump Type	Motor		m ³ /h	Head in meters															
				0,0	3,6	4,2	4,8	5,4	6	7	7,2	8	8,4	9	9,6	10,1	10,8	12	
	HP	KW	l/min	0	60	70	80	90	100	116,6	120	133,3	140	150	160	168,3	180	200	
SN 408 / 04	1	0,75		25	24	24	23	23	22	20	20	18	17	15	14	12	10	8	
SN 408 / 06	1,5	1,1		38	36	36	35	34	33	31	30	27	26	24	21	19	15	10	
SN 408 / 09	2	1,5		57	54	53	52	51	49	45	44	41	39	35	31	28	24	15	
SN 408 / 14	3	2,2		88	84	83	81	79	75	70	68	63	59	53	47	42	36	22	
SN 408 / 18	4	3		113	108	106	104	101	98	90	88	81	77	69	63	57	47	32	
SN 408 / 21	5	3,7		134	130	128	126	122	117	109	106	99	95	88	80	70	60	39	
SN 408 / 23	5,5	4		146	142	139	137	132	125	116	114	105	100	92	83	75	63	41	
SN 408 / 32	7,5	5,5		201	197	194	189	181	173	158	156	142	142	129	116	105	91	59	
SN 408 / 42	10	8		266	259	254	247	239	229	210	206	186	185	164	157	140	119	82	

* = motor unavailable

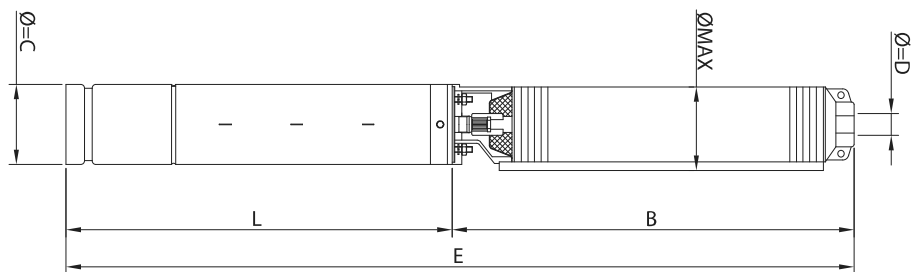

SN 408

50Hz - MANOMETRIC HEAD - PUMP EFFICIENCY

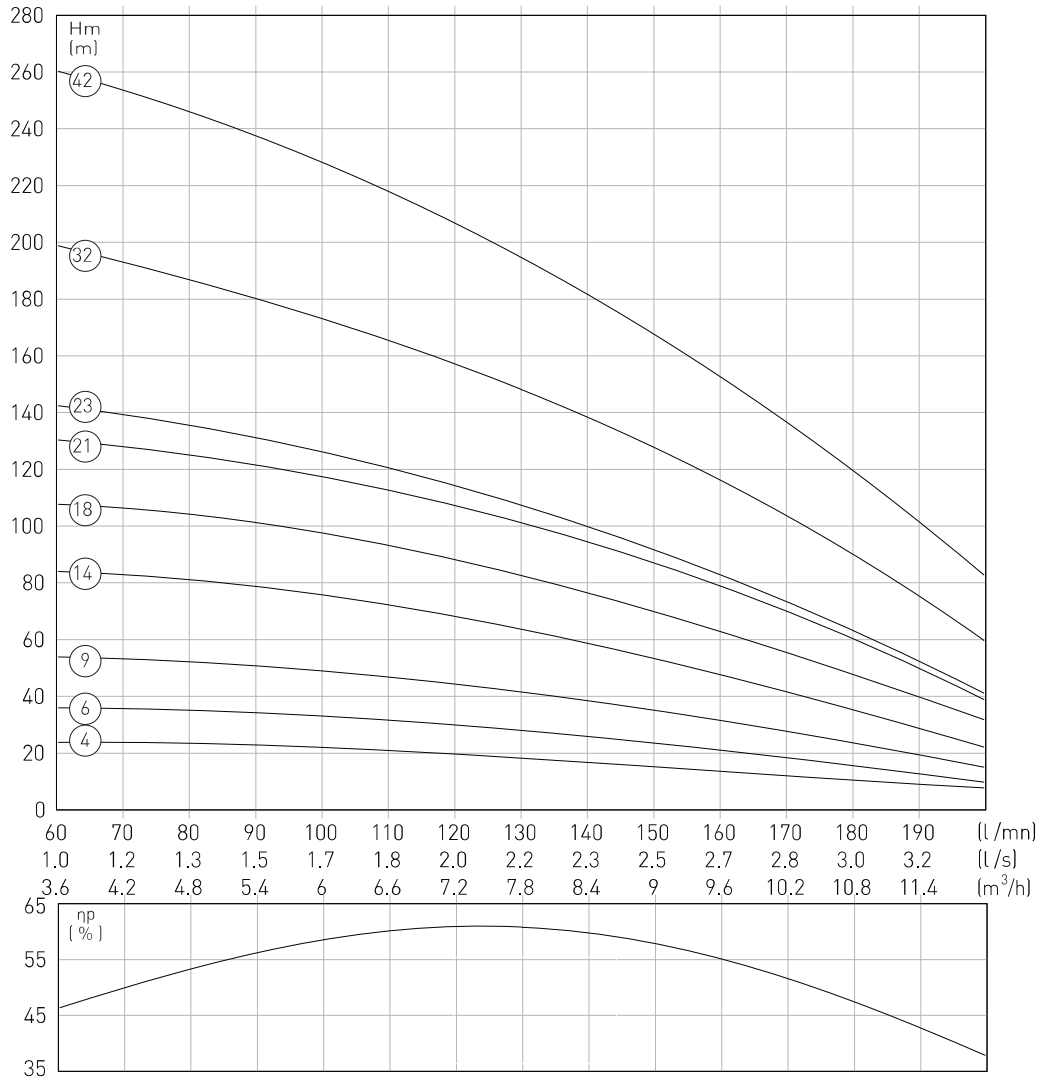

SN 409

50Hz - TECHNICAL INFORMATIONS

Pump Type	Motor		Dimensions (mm)								Weight (kg)				
			1~	3~	1~	3~				1~	3~		1~	3~	
	HP	KW	L	L	E	E	B	∅=C	∅=D	∅=MAX	Motor		Pump	Total	Total
SN 409 / 07	1,5	1,1	434	411	974	951	540	93	2"	95	11,4	10,6	3,9	15,3	14,5
SN 409 / 10	2	1,5	467	428	1190	1151	723	93	2"	95	12,8	10,8	5,1	17,9	15,9
SN 409 / 14	3	2,2	565	467	1492	1394	927	93	2"	95	17,4	12,5	6,9	24,3	19,4
SN 409 / 17	4	3	-	522	-	1632	1110	93	2"	95	-	15	8,2	-	23,2
SN 409 / 20	5	4	-	587	-	1850	1263	93	2"	95	-	18,3	9,7	-	28
SN 409 / 22	5,5	4	-	587	-	1982	1395	93	2"	95	-	18,3	10,7	-	29
SN 409 / 28	7,5	5,5	-	687	-	2388	1701	93	2"	95	-	24,3	13	-	37,3
SN 409 / 35	10	7,5	-	768	-	2856	2088	93	2"	95	-	28,3	16	-	44,3

Pump Type	Motor		m ³ /h	0,0	4,8	5,4	6	7	7,2	8	8,4	9	9,6	10,1	10,8	12	13	13,2	14	14,4
	HP	KW	l/min	0	80	90	100	116,6	120	133,3	140	150	160	168,3	180	200	216,6	220	233,3	240
			Head in meters																	
SN 409 / 07	1,5	1,1		40	36	35	31	33	32	31	29	28	26	24	22	18	16	15	13	12
SN 409 / 10	2	1,5		56	51	50	48	46	45	43	41	39	37	35	32	27	23	22	19	17
SN 409 / 14	3	2,2		78	71	69	68	65	64	60	57	54	51	48	44	37	31	30	26	24
SN 409 / 17	4	3		96	87	85	83	79	79	75	72	67	64	60	55	46	39	38	33	30
SN 409 / 20	5	4		116	107	105	102	97	96	91	89	83	80	75	69	58	50	49	42	39
SN 409 / 22	5,5	4		126	115	113	110	105	103	98	95	89	84	80	73	62	54	53	44	40
SN 409 / 28	7,5	5,5		165	154	150	145	138	136	131	124	121	117	111	102	90	79	78	68	64
SN 409 / 35	10	7,5	210	195	189	184	175	173	165	164	156	148	141	132	116	103	100	90	85	

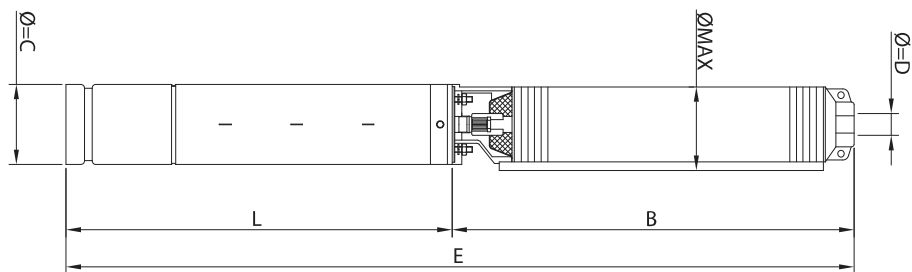

SN 409

50Hz - MANOMETRIC HEAD - PUMP EFFICIENCY

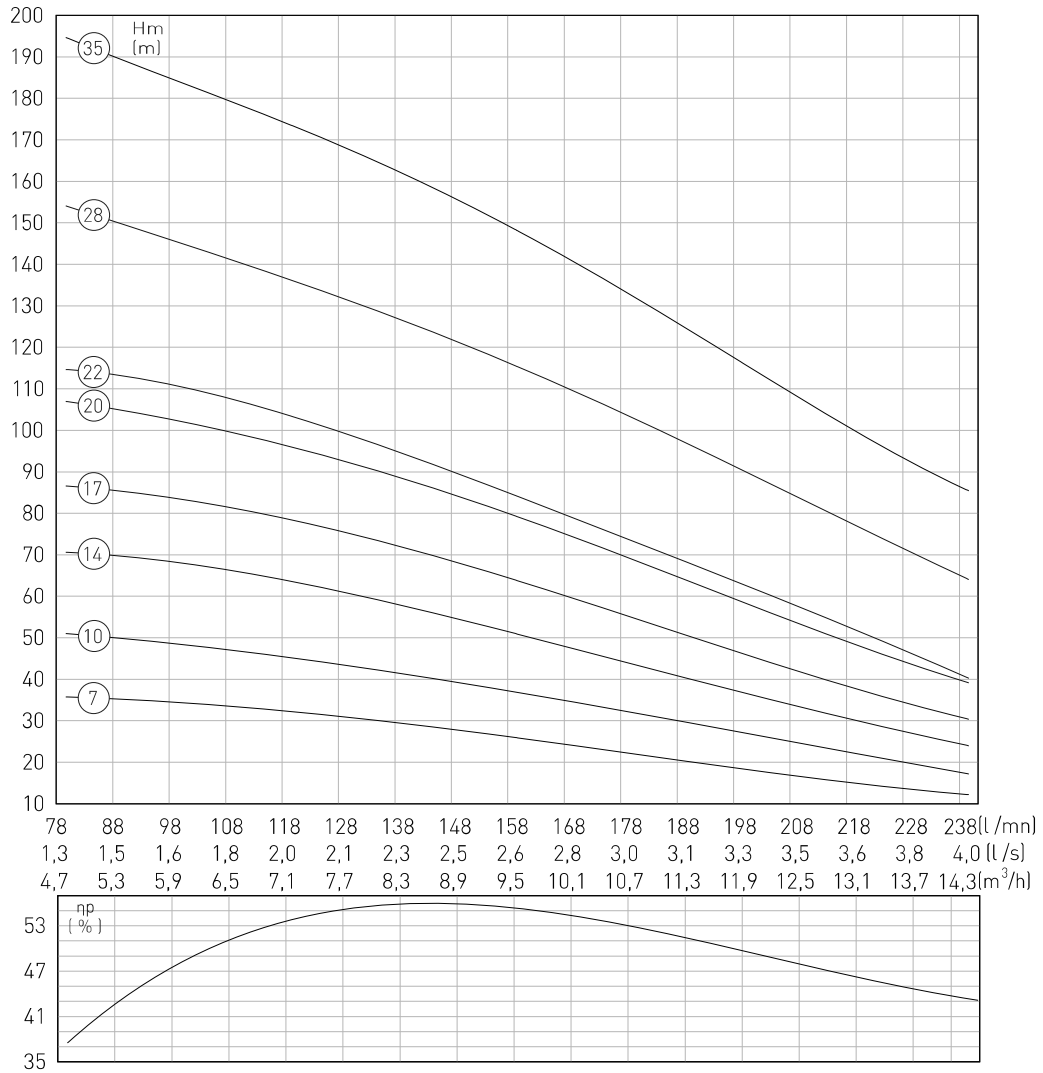

SN 415

50Hz - TECHNICAL INFORMATIONS

Pump Type	Motor		Dimensions (mm)								Weight (kg)				
			1~	3~	1~	3~				1~	3~		1~	3~	
	HP	KW	L	L	E	E	B	ø=C	ø=D	ø=MAX	Motor		Pump	Total	Total
SN 415 / 08	3	2,2	565	467	1251	1153	686	93	2"	95	17,4	12,5	5,4	22,8	1709
SN 415 / 10	4	3	-	522	-	1355	833	93	2"	95	-	15	6,4	-	21,4
SN 415 / 11	4	3	-	522	-	1429	907	93	2"	95	-	15	6,9	-	21,9
SN 415 / 12	4	3	-	522	-	1503	981	93	2"	95	-	15	7,4	-	22,4
SN 415 / 13	5	4	-	587	-	1641	1054	93	2"	95	-	18,3	8	-	26,3
SN 415 / 15	5,5	4	-	587	-	1789	1202	93	2"	95	-	18,3	9	-	27,3
SN 415 / 16	5,5	4	-	587	-	1863	1276	93	2"	95	-	18,3	9,5	-	27,8
SN 415 / 20	7,5	5,5	-	687	-	2257	1570	93	2"	95	-	24,3	11,6	-	35,9
SN 415 / 21	7,5	5,5	-	687	-	2331	1644	93	2"	95	-	24,3	12,1	-	36,4
SN 415 / 28	10	7,5	-	768	-	2927	2159	93	2"	95	-	28,3	15,8	-	44,1

Pump Type	Motor		m³/h	Head in meters															
	HP	KW		l/min	0,0	9	10	11	12	13	14	15	16	17	18	19	20	21	22
SN 415 / 08	3	2,2	46	34	33	31	30	28	26	25	23	22	20	18	16	14	12	10	7
SN 415 / 10	4	3	57	43	41	39	37	35	33	32	29	27	25	23	21	18	16	13	9
SN 415 / 11	4	3	63	48	45	43	41	39	37	35	33	30	28	26	24	21	18	15	11
SN 415 / 12	4	3	69	55	51	48	46	43	41	39	37	34	32	30	27	24	20	17	12
SN 415 / 13	5	4	75	60	55	52	49	47	44	42	40	37	35	32	29	26	22	18	13
SN 415 / 15	5,5	4	87	72	66	61	58	55	52	49	47	45	42	39	35	31	26	21	15
SN 415 / 16	5,5	4	95	78	72	67	63	60	46	53	50	47	44	41	37	33	27	22	16
SN 415 / 20	7,5	5,5	121	98	92	86	81	76	71	67	62	58	54	50	45	40	34	27	18
SN 415 / 21	7,5	5,5	127	103	97	90	85	80	75	70	65	61	57	53	47	42	36	28	19
SN 415 / 28	10	7,5	165	130	121	112	105	98	92	86	80	74	68	62	56	49	42	34	25

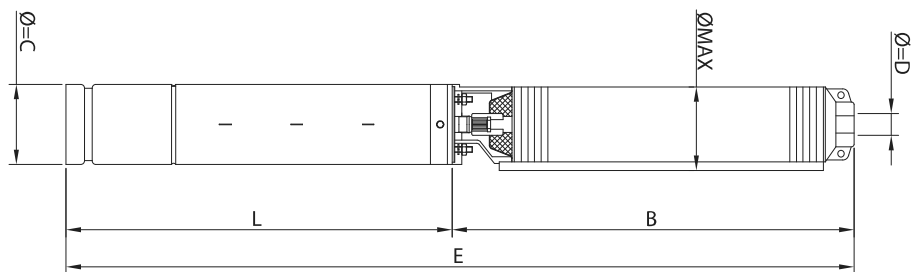

SN 415

50Hz - MANOMETRIC HEAD - PUMP EFFICIENCY

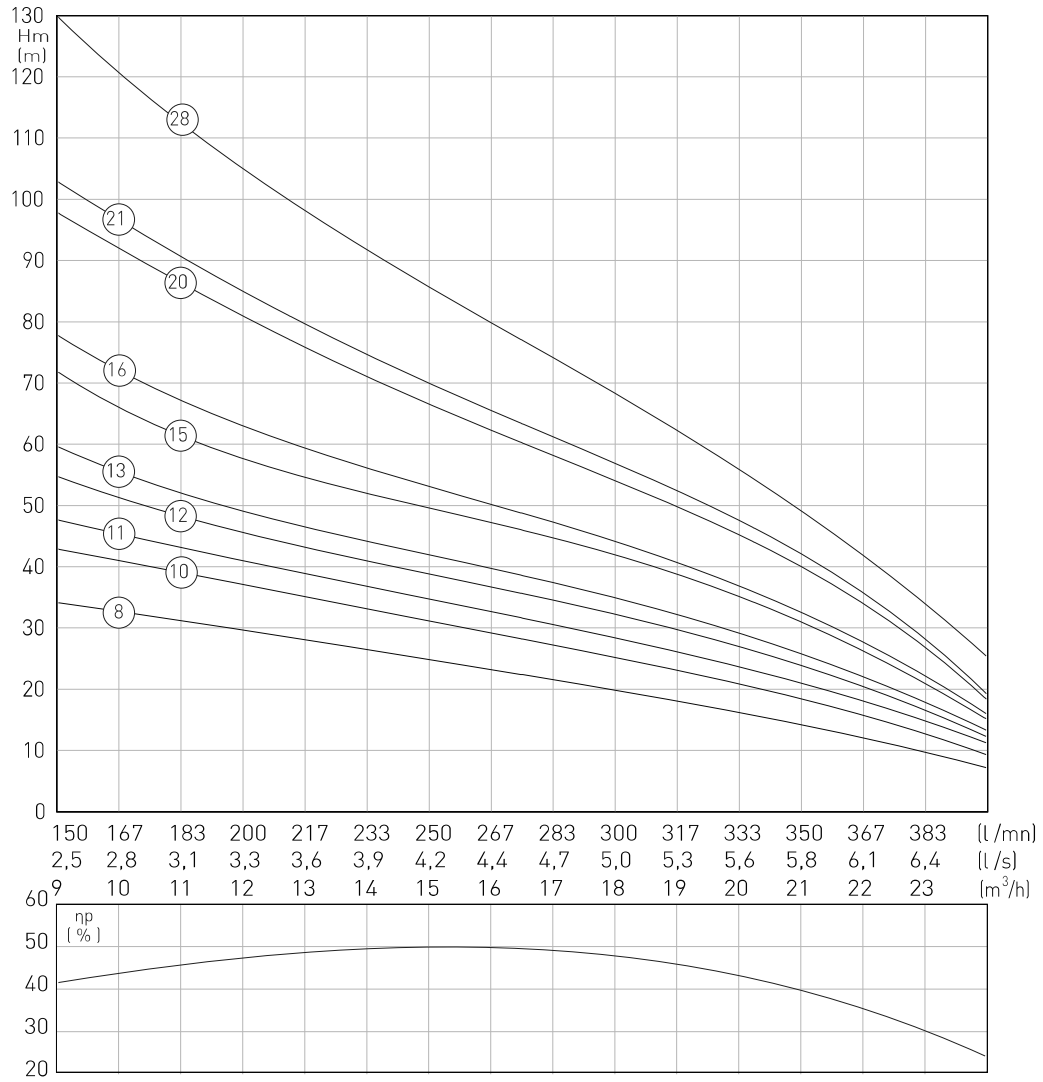

SN 404

50Hz - TECHNICAL DRAWING

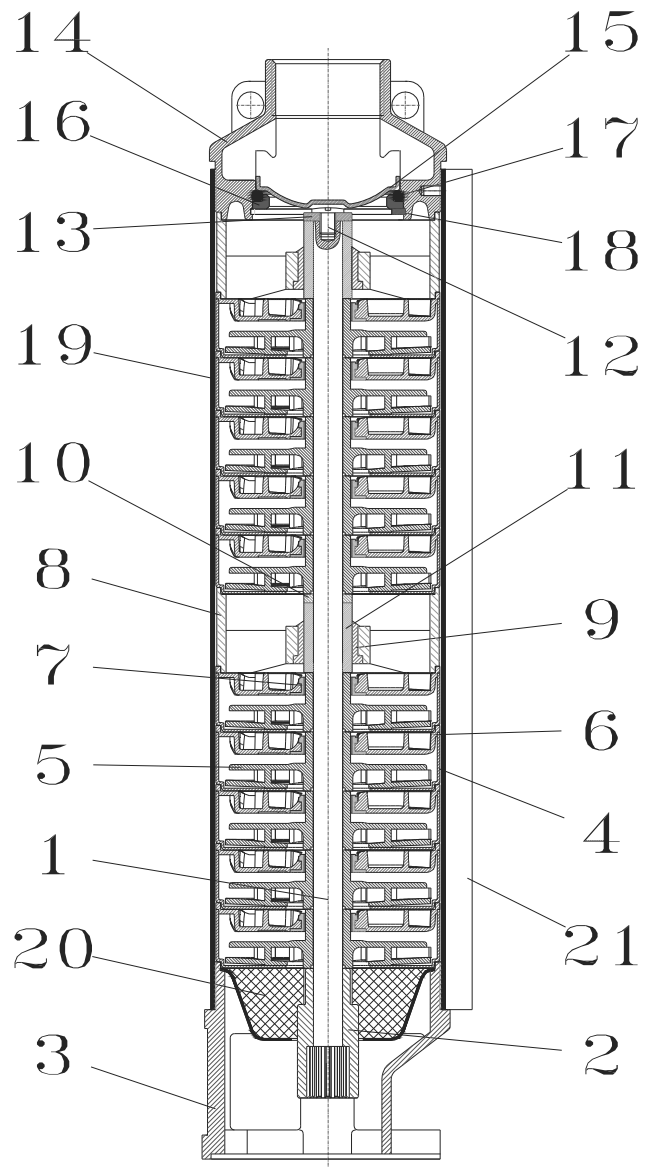

SN 404

50Hz MATERIAL LIST

No	JDE KOD	PART NAME	MATERIAL
1	A*	Shaft	Stainless steel (AISI 304)
2	100611841100600	Coupling	Stainless steel (AISI 304)
3	197611640000609	Support	Stainless steel (AISI 304)
4	100610444010609	Body	Stainless steel (AISI 304 AISI 430)
5	100411244010709	Impeller	Poly carbonate
6	100610844010709	Diffuser	Noryl
7	100614441100700	Bearing	Resine
8	100413640000709	Bearing housing	Resine
9	100613840000709	Bearing	Resine
10	100614240005709	Bushing	Poly carbonate
11	100614042011600	Bushing	Stainless steel (AISI 316)
12	100615840000600	Screw	Stainless steel (AISI 304)
13	100616040000600	Washer	Stainless steel (AISI 316)
14	100411041401609	Discharge 1 1/4" 11 TPI	Stainless steel (AISI 304)
15	100615040000609	Check valve disc	Stainless steel (AISI 304)
16	100612640000600	Check valve ring	Stainless steel (AISI 420)
17	100615640000700	Check valve ring oring	Rubber
18	100614940000600	Check valve snap ring	Stainless steel (AISI 304)
19	A*	Housing	Stainless steel (AISI 304)
20	100612840000609	Strainer	Stainless steel (AISI 304)
21	A*	Cable guard	Stainless steel (AISI 304)

SN 406

50Hz - TECHNICAL DRAWING

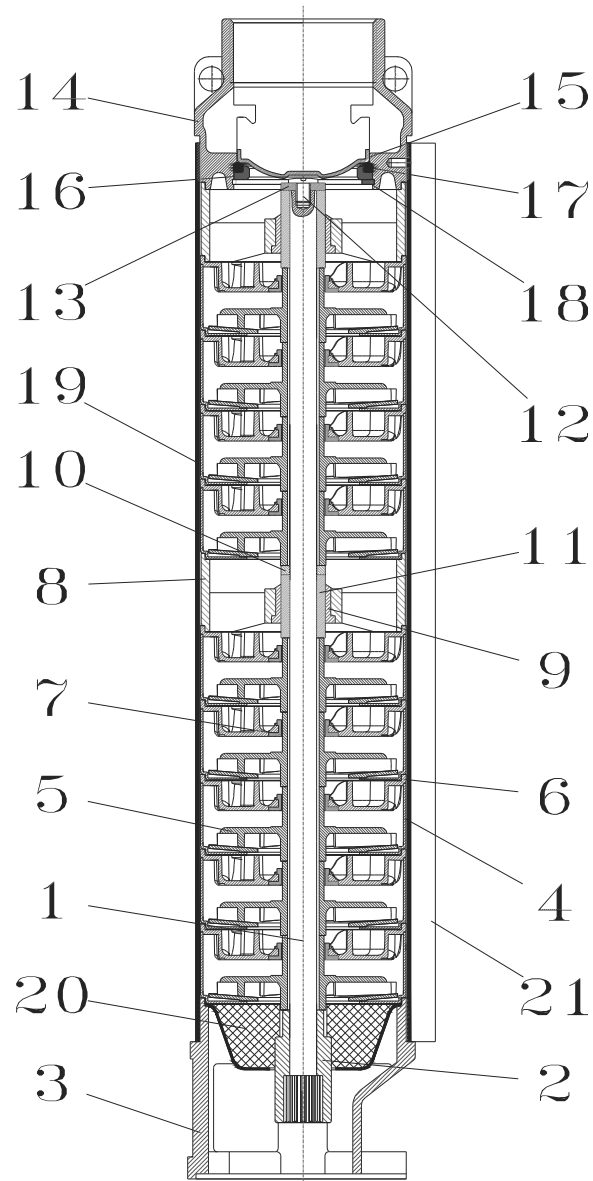

SN 406

50Hz MATERIAL LIST

No	JDE KOD	PART NAME	MATERIAL
1	A*	Shaft	Stainless steel (AISI 304)
2	100611841100600	Coupling	Stainless steel (AISI 304)
3	197611640000609	Support	Stainless steel (AISI 304)
4	100610444010609	Body	Stainless steel (AISI 304 - AISI 430)
5	100411244010709	Impeller	Poly carbonate
6	100610844010709	Diffuser	Noryl
7	100614441100700	Bearing	Resine
8	100413640000709	Bearing housing	Resine
9	100613840000709	Bearing	Resine
10	100614240005709	Bushing	Poly carbonate
11	100614042011600	Bushing	Stainless steel (AISI 316)
12	100615840000600	Screw	Stainless steel (AISI 304)
13	100616040000600	Washer	Stainless steel (AISI 316)
14	197611042001609	Discharge 2" 11 TPI	Stainless steel (AISI 304)
15	100615040000609	Check valve disc	Stainless steel (AISI 304)
16	100612640000600	Check valve ring	Stainless steel (AISI 420)
17	100615640000700	Check valve ring oring	Rubber
18	100614940000600	Check valve snap ring	Stainless steel (AISI 304)
19	A*	Housing	Stainless steel (AISI 304)
20	100612840000609	Strainer	Stainless steel (AISI 304)
21	A*	Cable guard	Stainless steel (AISI 304)

SN 408

50Hz - TECHNICAL DRAWING

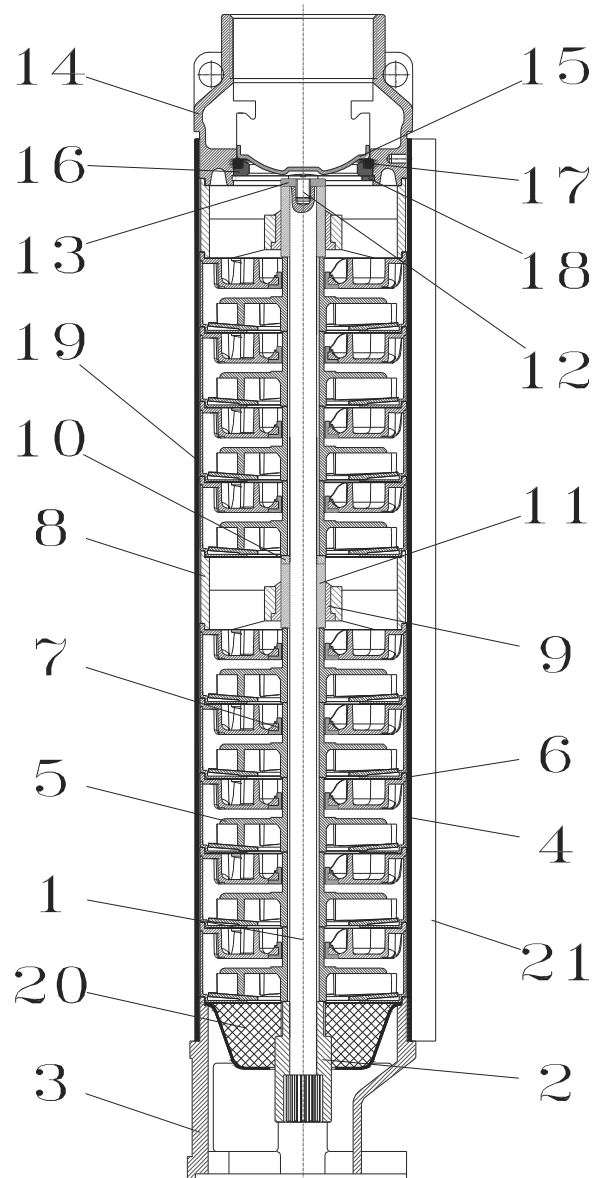

SN 408

50Hz MATERIAL LIST

No	JDE KOD	PART NAME	MATERIAL
1	A*	Shaft	Stainless steel (AISI 304)
2	100611841100600	Coupling	Stainless steel (AISI 304)
3	197611640000609	Support	Stainless steel (AISI 304)
4	100610444010609	Body	Stainless steel (AISI 304 - AISI 430)
5	100411244010709	Impeller	Poly carbonate
6	100610844010709	Diffuser	Noryl
7	100614441100700	Bearing	Resine
8	100413640000709	Bearing housing	Resine
9	100613840000709	Bearing	Resine
10	100614240005709	Bushing	Poly carbonate
11	100614042011600	Bushing	Stainless steel (AISI 316)
12	100615840000600	Screw	Stainless steel (AISI 304)
13	100616040000600	Washer	Stainless steel (AISI 316)
14	197611042001609	Discharge 2" 11 TPI	Stainless steel (AISI 304)
15	100615040000609	Check valve disc	Stainless steel (AISI 304)
16	100612640000600	Check valve ring	Stainless steel (AISI 420)
17	100615640000700	Check valve ring oring	Rubber
18	100614940000600	Check valve snap ring	Stainless steel (AISI 304)
19	A*	Housing	Stainless steel (AISI 304)
20	100612840000609	Strainer	Stainless steel (AISI 304)
21	A*	Cable guard	Stainless steel (AISI 304)

SN 409

50Hz - TECHNICAL DRAWING

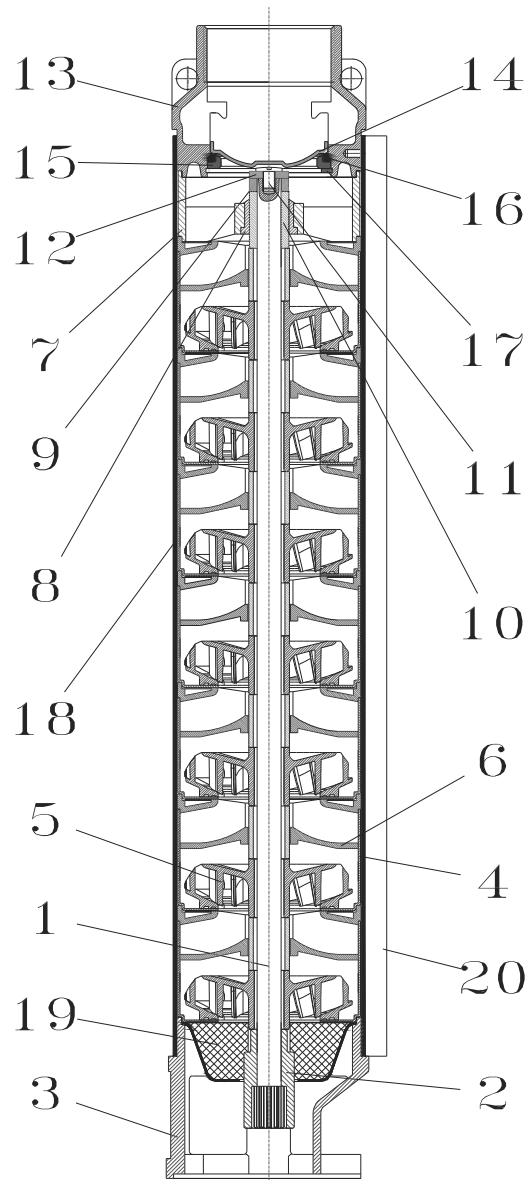

SN 409

50Hz MATERIAL LIST

No	JDE KOD	PART NAME	MATERIAL
1	A*	Shaft	Stainless steel (AISI 304)
2	100611841100600	Coupling	Stainless steel (AISI 304)
3	197611640000609	Support	Stainless steel (AISI 304)
4	100610444010609	Body	Stainless steel (AISI 304 - AISI 430)
5	100411244010709	Impeller	Poly carbonate
6	100610844010709	Diffuser	Noryl
7	100413640000709	Bearing housing	Resine
8	100613840000709	Bearing	Resine
9	100614240005709	Bushing	Poly carbonate
10	100614042011600	Bushing	Stainless steel (AISI 316)
11	100615840000600	Screw	Stainless steel (AISI 304)
12	100616040000600	Washer	Stainless steel (AISI 316)
13	197611042001609	Discharge 2" 11 TPI	Stainless steel (AISI 304)
14	100615040000609	Check valve disc	Stainless steel (AISI 304)
15	100612640000600	Check valve ring	Stainless steel (AISI 420)
16	100615640000700	Check valve ring oring	Rubber
17	100614940000600	Check valve snap ring	Stainless steel (AISI 304)
18	A*	Housing	Stainless steel (AISI 304)
19	100612840000609	Strainer	Stainless steel (AISI 304)
20	A*	Cable guard	Stainless steel (AISI 304)

SN 415

50Hz - TECHNICAL DRAWING

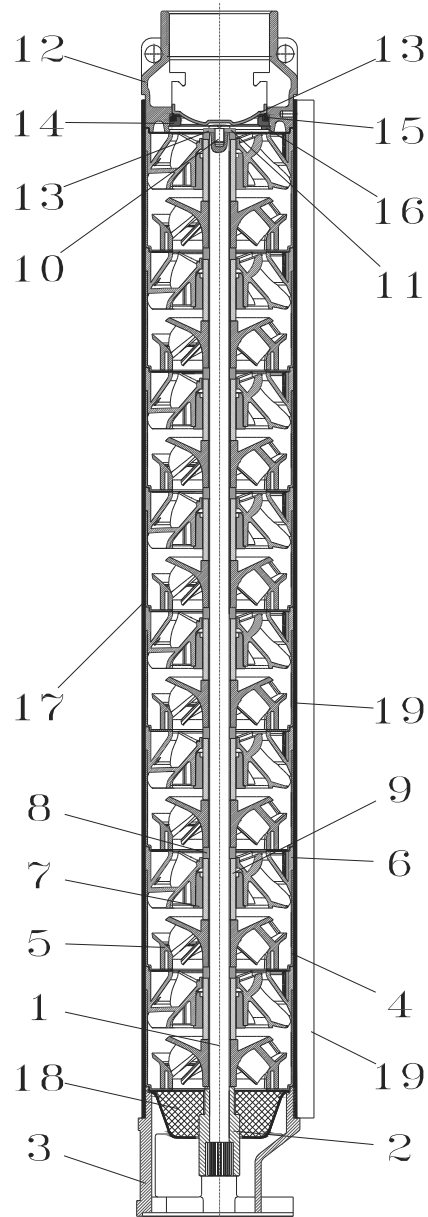

SN 415

50Hz MATERIAL LIST

No	JDE KOD	PART NAME	MATERIAL
1	A*	Shaft	Stainless steel (AISI 304)
2	100611841200600	Coupling	Stainless steel (AISI 304)
3	197611640000609	Support	Stainless steel (AISI 304)
4	100610444150609	Body	Stainless steel (AISI 304 - AISI 430)
5	100411244150709	Impeller	Poly carbonate
6	100410844150709	Diffuser	Noryl
7	100614444150709	Bearing	Resine
8	100614240006709	Bushing	Poly carbonate
9	100614043512600	Bushing	Stainless steel (AISI 316)
10	100615840000600	Screw	Stainless steel (AISI 304)
11	100616040000600	Washer	Stainless steel (AISI 316)
12	197611042001609	Discharge 2" 11 TPI	Stainless steel (AISI 304)
13	100615040000609	Check valve disc	Stainless steel (AISI 304)
14	100612640000600	Check valve ring	Stainless steel (AISI 420)
15	100615640000700	Check valve ring oring	Rubber
16	100614940000600	Check valve snap ring	Stainless steel (AISI 304)
17	A*	Housing	Stainless steel (AISI 304)
18	100612840000609	Strainer	Stainless steel (AISI 304)
19	A*	Cable guard	Stainless steel (AISI 304)