

## STAINLESS STEEL CENTRIFUGAL PUMPS

End suction centrifugal pumps made of stainless steel AISI 304 (3 Series) and AISI 316L (3L Series). Suitable for water boosting, heating systems, air-conditioning, washing systems, irrigation, cooling and many other industrial applications.



### SPECIFICATIONS

- Maximum working pressure : 10 bar
- Maximum liquid temperature : from -10°C to +90°C from -10°C to +110°C (L-H-HS versions)

### MATERIALS

- Pump body and casing cover in:
  - AISI 304 for **3 Series** 32-125/160/200  
40-125/160/200  
50-125/160  
65-125/160/200
  - AISI 316L for **3L Series** 32-125/160/200  
40-125/160/200  
50-125/160  
65-125/160/200
  - AISI 316 microcasted for **3L Series** 65-250  
80-160/200/250
- Impeller in:
  - AISI 304 for **3 Series** 32-125/160/200  
40-125/160/200  
50-125/160
  - AISI 316L for **3L Series** 32-125/160/200  
40-125/160/200  
50-125/160
  - AISI 316 microcasted for **3 Series** 65-125/160/200  
**3L Series** 65-125/160/200  
65-250  
80-160/200/250
- Mechanical seal in:
  - Carbon/Ceramic/NBR for **3 Series** 32-125/160/200  
40-125/160/200  
50-125/160  
65-125/160/200
  - SiC/SiC/FPM for **3L Series** 32-125/160/200  
40-125/160/200  
50-125/160  
65-125/160/200/250  
80-160/200/250
- Special mechanical seal available on request

### TECHNICAL DATA

- Asynchronous 2 and 4 poles motor
- Insulation: Class F (B for temperature rise)
- Protection degree: IP55
- 1~230V ± 10%, 50Hz,  
3~220-240/380-415V ± 5% (up to 4kW included), 50Hz  
3~380-415/660-720V ± 10% (5.5kW and above), 50Hz
- Thermal protection to be provided by the user

Available in 4 different versions, 2 and 4 poles

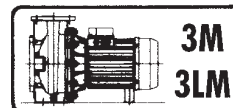

monobloc with extended motor shaft

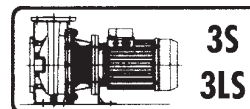

monobloc with standard motor and flexible coupling

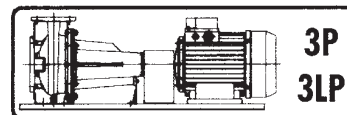

on basement with standard motor and flexible coupling

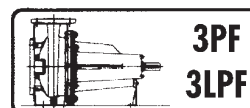

bareshaft pump

**PERFORMANCE CHART**
**2 Poles**

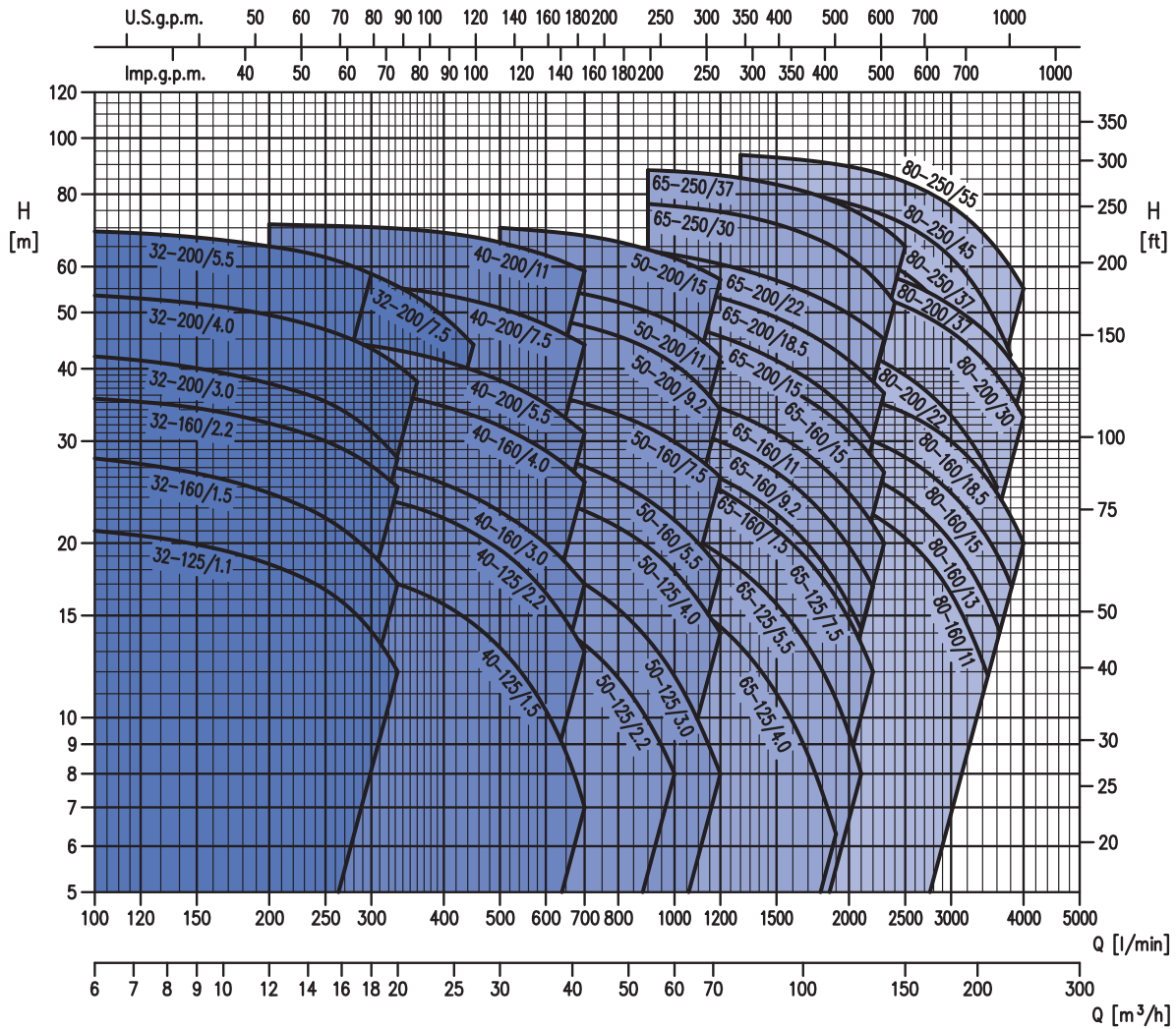
 at 2900 min<sup>-1</sup> (according to ISO 9906 Annex A)

	Version	3M	3S	3P	3LM	3LS	3LP
Pump size	32-125	√	√	√	√	√	√
	32-160	√	√	√	√	√	√
	32-200	√	√	√	√	√	√
	40-125	√	√	√	√	√	√
	40-160	√	√	√	√	√	√
	40-200	√	√	√	√	√	√
	50-125	√	√	√	√	√	√
	50-160	√	√	√	√	√	√
	50-200	√	√	√	√	√	√
	65-125	√	√	√	√	√	√
	65-160	√	√	√	√	√	√
	65-200	√	√	√	√	√	√
	65-250	-	-	-	-	•	•
	80-160	-	-	-	•	•	•
	80-200	-	-	-	-	•	•
	80-250	-	-	-	-	•	•

√ = Available also with H and HS option for 32, 40, 50, 65-125/160/200  
 • = Available also with H option for 65-250, 80  
 - = Not available

**PERFORMANCE TABLE 32-40-50**
**2 Poles**

Model	kW	HP	Q=Capacity															
			l/min	0	100	150	200	300	333	360	400	450	500	600	700	800	1000	1200
			m <sup>3</sup> /h	0	6	9	12	18	20	22	24	27	30	36	42	48	60	72
			H=Total head (m)															
32-125/1.1(M)	1.1	1.5	22.5	21	19.9	18.4	14.1	12	-	-	-	-	-	-	-	-	-	
32-160/1.5(M)	1.5	2	29.5	28	26.5	24.5	19.2	17	-	-	-	-	-	-	-	-	-	
32-160/2.2(M)	2.2	3	37	35.5	34	32	27	25	-	-	-	-	-	-	-	-	-	
32-200/3.0	3	4	44	42	40	37.5	31	28	-	-	-	-	-	-	-	-	-	
32-200/4.0	4	5.5	55	53.5	52	49.5	43.5	40.5	38	-	-	-	-	-	-	-	-	
32-200/5.5	5.5	7.5	70.5	69	67.5	65	58.5	-	-	-	-	-	-	-	-	-	-	
32-200/7.5	7.5	10	70.5	69	67.5	65	58.5	55.5	53	49	44	-	-	-	-	-	-	
40-125/1.5(M)	1.5	2	20	-	-	19	17.6	17	16.5	15.7	14.5	13.2	10.3	7	-	-	-	
40-125/2.2(M)	2.2	3	26.5	-	-	25.5	24	23.5	23	22	21	19.5	16.4	13	-	-	-	
40-160/3.0	3	4	31	-	-	29.5	27.5	27	26.5	25.5	24	22.5	20	17	-	-	-	
40-160/4.0	4	5.5	40	-	-	38.5	37	36	35.5	34.5	33	32	29	25.5	-	-	-	
40-200/5.5	5.5	7.5	47	-	-	45.5	44	43	42.5	41	39.5	38	35	31	-	-	-	
40-200/7.5	7.5	10	58	-	-	57	55.5	55	54.5	53.5	52.5	51	47.5	44	-	-	-	
40-200/11	11	15	72	-	-	71	70	70	69.5	68.5	67.5	66	63	59	-	-	-	
50-125/2.2(M)	2.2	3	19	-	-	-	-	-	-	17.5	17	16.3	14.9	13.4	11.7	8	-	
50-125/3.0	3	4	22	-	-	-	-	-	-	20.5	20	19.6	18.4	17	15.4	11.8	8	
50-125/4.0	4	5.5	26.5	-	-	-	-	-	-	26	25.5	25	24	22.5	21.5	17.9	14	
50-160/5.5	5.5	7.5	33	-	-	-	-	-	-	31	30.5	30	28.5	27	25.5	22	18	
50-160/7.5	7.5	10	40	-	-	-	-	-	-	38.5	38	37.5	36	35	33.5	30	26	
50-200/9.2	9.2	12.5	53	-	-	-	-	-	-	-	-	50	49	47.5	45.5	40.5	34	
50-200/11	11	15	59	-	-	-	-	-	-	-	-	56	55	54	52	48	42	
50-200/15	15	20	72	-	-	-	-	-	-	-	-	70	69	68	66	62	57	

(M) Single phase version only for 3M type

**PERFORMANCE TABLE 65-80**
**2 Poles**

Model	kW	HP	Q=Capacity																		
			l/min	0	600	700	900	1300	1500	1700	1900	2100	2200	2300	2400	2500	3000	3400	3600	3800	4000
			m <sup>3</sup> /h	0	36	42	54	78	90	102	114	126	132	138	144	150	180	204	216	228	240
			H=Total head (m)																		
65-125/4.0	4	5.5	22.2	19.8	19	17.3	13.3	11	8.6	6.3	-	-	-	-	-	-	-	-	-	-	
65-125/5.5	5.5	7.5	27	-	24	22.2	18	15.7	13.3	10.8	8	-	-	-	-	-	-	-	-	-	
65-125/7.5	7.5	10	32	-	29.5	27.8	23.5	21.1	18.7	16.1	13.4	12	-	-	-	-	-	-	-	-	
65-160/7.5	7.5	10	32	-	30	28.6	24.8	22.5	19.9	17.1	14.2	-	-	-	-	-	-	-	-	-	
65-160/9.2	9.2	12.5	36.5	-	34.5	32.8	28.8	26.5	23.9	21.1	18.3	16.8	-	-	-	-	-	-	-	-	
65-160/11	11	15	40.5	-	38.5	37.1	33.1	30.9	28.4	25.8	23	21.5	20	-	-	-	-	-	-	-	
65-160/15	15	20	48	-	45.5	44	40	37.8	35.3	32.6	29.6	28	26.5	-	-	-	-	-	-	-	
65-200/15	15	20	53.5	-	51	49	44	41.5	38.4	35.3	31.8	30	-	-	-	-	-	-	-	-	
65-200/18.5	18.5	25	60.5	-	58.5	56.5	51.5	49	46	43	39.7	38	36.3	-	-	-	-	-	-	-	
65-200/22	22	30	67	-	65.5	64	59.5	57	54	51	48	46.5	45	-	-	-	-	-	-	-	
65-250/30	30	40	78	-	-	77	73.5	71	68	64.5	60	57.5	55	52	-	-	-	-	-	-	
65-250/37	37	50	89	-	-	88	85.5	83	80.5	77.5	74	72	70	67.5	65	-	-	-	-	-	
80-160/11	11	15	29	-	-	-	27.3	26.4	25.4	24.2	23	22.4	21.8	21.1	20.4	16.4	12.5	-	-	-	
80-160/13	13	7.5	32	-	-	-	30.5	29.7	28.8	27.7	26.5	25.9	25.3	24.6	24	20.1	16.5	14.5	-	-	
80-160/15R	15	20	32	-	-	-	30.5	29.7	28.8	27.7	26.5	25.9	25.3	24.6	24	20.1	16.5	14.5	-	-	
80-160/15	15	20	35	-	-	-	34	33.3	32.5	31.5	30.5	30	29.4	28.8	28.1	24.4	21	19.1	17	-	
80-160/18.5	18.5	25	40	-	-	-	39	38.4	37.6	36.7	35.7	35.2	34.7	34.1	33.5	30	26.4	24.4	22.3	20	
80-200/22	22	30	50	-	-	-	48	47	45.5	44.5	43	42	41	40	39	33.2	27.8	25	-	-	
80-200/30	30	40	60	-	-	-	58.5	58	57	56	54.5	54	53	52	51	46.5	41.5	39	36.1	33	
80-200/37	37	50	66	-	-	-	64	63	62	61	59.5	59	58	57.5	56.5	51.5	47	44.5	41.5	38.5	
80-250/37	37	50	73	-	-	-	71.5	70.5	68.5	66.5	64	63	61.5	60	58.5	48.5	38	-	-	-	
80-250/45	45	60	84	-	-	-	82.5	81.5	80	78	76	75	73.5	72.5	71	62	53	48	42.5	-	
80-250/55	55	75	95	-	-	-	93.5	92.5	91.5	90	88.5	87.5	86.5	85.5	84	76.5	68.5	64.5	60	55	

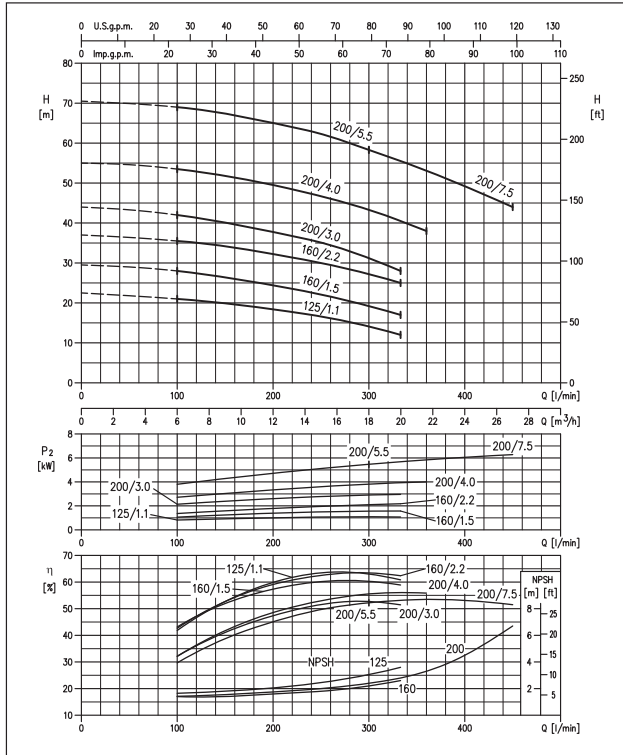
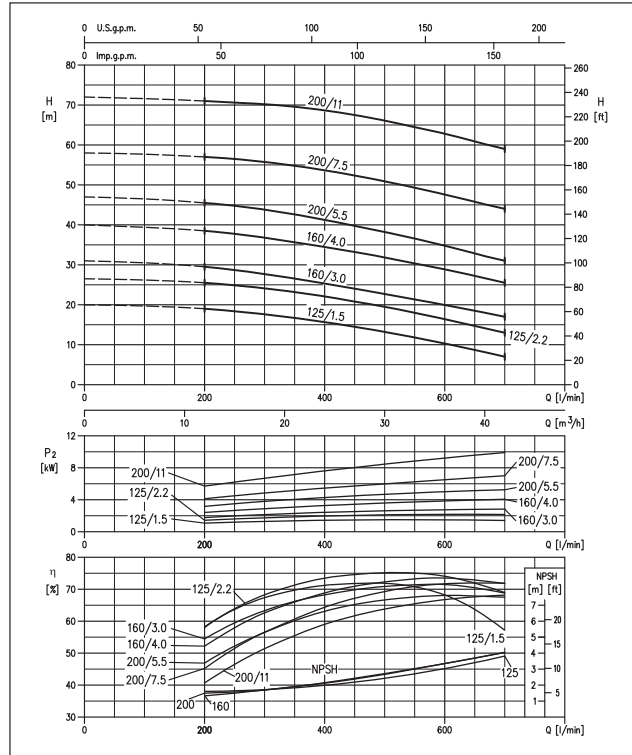
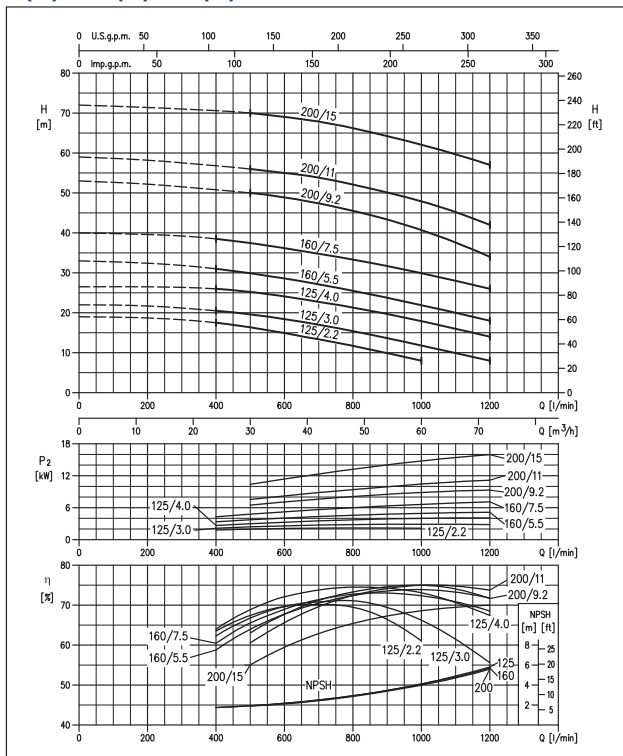
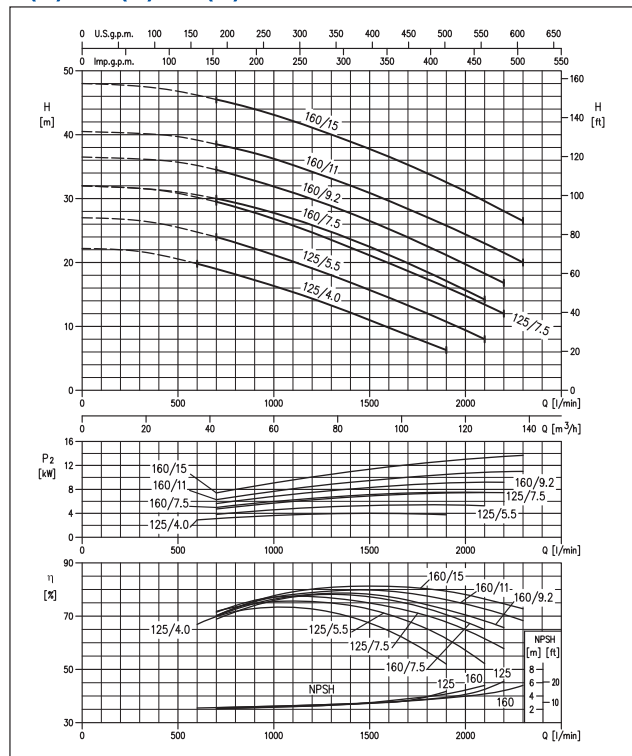
**PERFORMANCE CURVE**
**2 Poles**
**3(L)M-3(L)S-3(L)P 32**

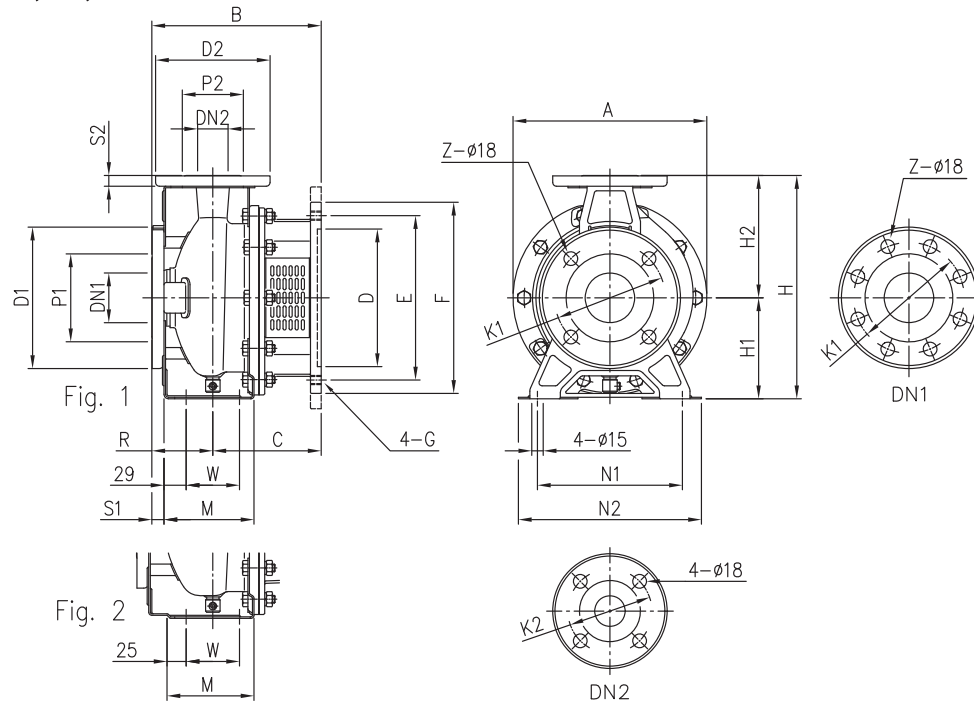
**3(L)M-3(L)S-3(L)P 40**

**3(L)M-3(L)S-3(L)P 50**

**3(L)M-3(L)S-3(L)P 65**

**DIMENSION**
**2 Poles**
**3(.)SF 32, 40, 50, 65**

**DIMENSIONAL TABLE**

Model	Fig.	Dimensions [mm]																				Weight [kg]							
		DN1	P1	K1	D1	S1	Z [1]	Z [2]	DN2	P2	K2	D2	S2	H	H1	H2	M	N1	N2	R	W		A	B	C	D	E	F	G
32-200/3	1	50	95	125	165	16	4	-	32	75	100	140	14	340	160	180	119	190	240	80	70	296	222	142	180	215	250	M12	24
32-200/4	1	50	95	125	165	16	4	-	32	75	100	140	14	340	160	180	119	190	240	80	70	296	222	142	180	215	250	M12	24
32-200/5.5	1	50	95	125	165	16	4	-	32	75	100	140	14	340	160	180	119	190	240	80	70	296	245	165	230	265	300	M12	28
32-200/7.5	1	50	95	125	165	16	4	-	32	75	100	140	14	340	160	180	119	190	240	80	70	296	245	165	230	265	300	M12	28
40-160/3	1	65	115	145	185	16	4	-	40	80	110	150	14	292	132	160	118	190	240	80	70	254	222	142	180	215	250	M12	19.5
40-160/4	1	65	115	145	185	16	4	-	40	80	110	150	14	292	132	160	118	190	240	80	70	254	222	142	180	215	250	M12	20
40-200/5.5	2	65	115	145	185	16	4	-	40	80	110	150	14	340	160	180	115	212	265	100	70	296	265	165	230	265	300	M12	28
40-200/7.5	2	65	115	145	185	16	4	-	40	80	110	150	14	340	160	180	115	212	265	100	70	296	265	165	230	265	300	M12	28
40-200/11	2	65	115	145	185	16	4	-	40	80	110	150	14	340	160	180	115	212	265	100	70	296	298	198	250	300	350	M16	41.5
50-125/3	2	65	115	145	185	16	4	-	50	95	125	165	16	292	132	160	114	190	240	100	70	254	242	142	180	215	250	M12	20
50-125/4	2	65	115	145	185	16	4	-	50	95	125	165	16	292	132	160	114	190	240	100	70	254	242	142	180	215	250	M12	20
50-160/5.5	2	65	115	145	185	16	4	-	50	95	125	165	16	340	160	180	115	212	265	100	70	296	265	165	230	265	300	M12	28.5
50-160/7.5	2	65	115	145	185	16	4	-	50	95	125	165	16	340	160	180	115	212	265	100	70	296	265	165	230	265	300	M12	28.5
50-200/9.2	2	65	115	145	185	16	4	-	50	95	125	165	16	360	160	200	115	212	265	100	70	296	265	165	230	265	300	M12	29
50-200/11	2	65	115	145	185	16	4	-	50	95	125	165	16	360	160	200	115	212	265	100	70	296	298	198	250	300	350	M16	41.5
50-200/15	2	65	115	145	185	16	4	-	50	95	125	165	16	360	160	200	115	212	265	100	70	296	298	198	250	300	350	M16	42.5
65-125/4	2	80	134	160	200	18	8	4	65	115	145	185	16	340	160	180	140	212	280	100	95	254	242	142	180	215	250	M12	26
65-125/5.5	2	80	134	160	200	18	8	4	65	115	145	185	16	340	160	180	140	212	280	100	95	254	265	165	230	265	300	M12	27.5
65-125/7.5	2	80	134	160	200	18	8	4	65	115	145	185	16	340	160	180	140	212	280	100	95	254	265	165	230	265	300	M12	28.5
65-160/7.5	2	80	134	160	200	18	8	4	65	115	145	185	16	360	160	200	140	212	280	100	95	296	265	165	230	265	300	M12	27
65-160/9.2	2	80	134	160	200	18	8	4	65	115	145	185	16	360	160	200	140	212	280	100	95	296	265	165	230	265	300	M12	30
65-160/11	2	80	134	160	200	18	8	4	65	115	145	185	16	360	160	200	140	212	280	100	95	296	298	198	250	300	350	M16	40
65-160/15	2	80	134	160	200	18	8	4	65	115	145	185	16	360	160	200	140	212	280	100	95	296	308	208	250	300	350	M16	42
65-200/15	2	80	134	160	200	18	8	4	65	115	145	185	16	405	180	225	140	250	320	100	95	296	308	208	250	300	350	M16	29.5
65-200/18.5	2	80	134	160	200	18	8	4	65	115	145	185	16	405	180	225	140	250	320	100	95	296	308	208	250	300	350	M16	29.5
65-200/22	2	80	134	160	200	18	8	4	65	115	145	185	16	405	180	225	140	250	320	100	95	296	308	208	250	300	350	M16	30

[1] Standard  
[2] On request